

1. Simple Loop

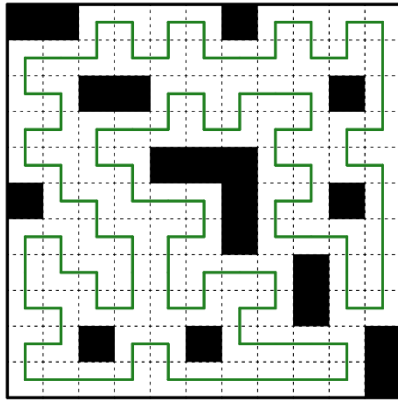

2. Masyu

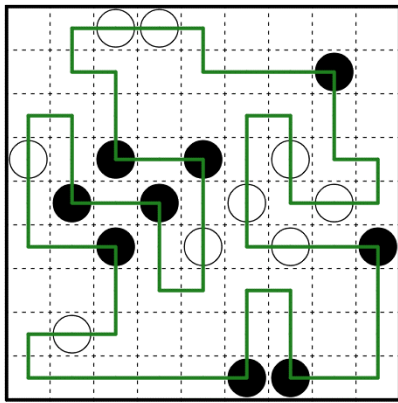

3. Tents

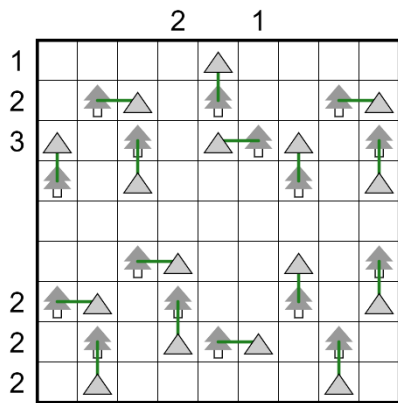

4. Fillomino

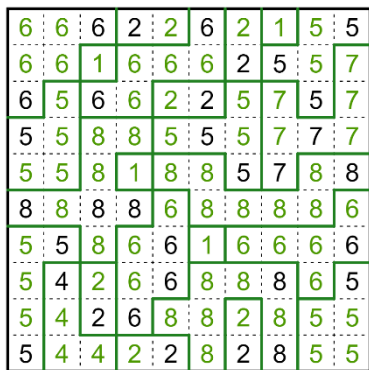

5. Coral

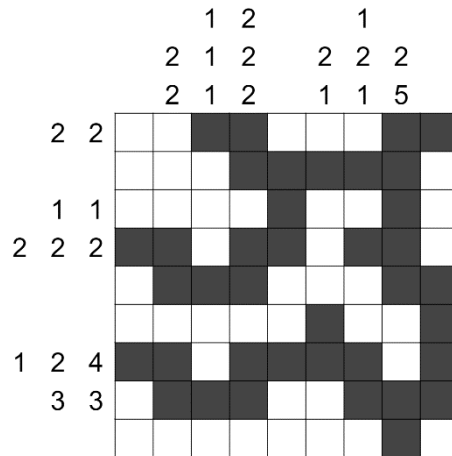

6. Heyawake

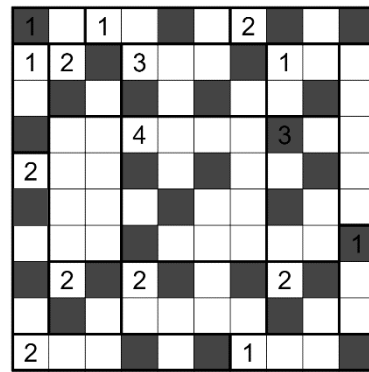

7. Slitherlink

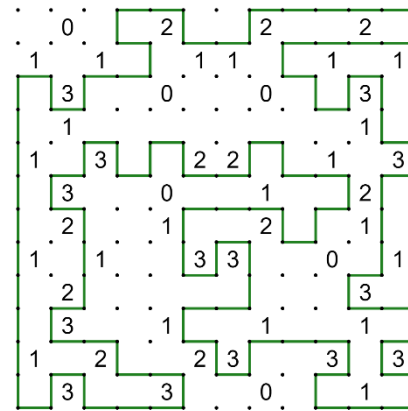

8. Easy As (Non-Adjacent Duplicates)

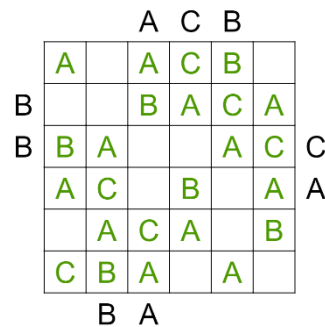

9. Easy As (No-Touch)

C				
B	B	C		A
	C		A	B
	A		B	C
	B	C		A
A		A		B
	A		B	C

10. Easy As (No-Touch)

				B	A		A	A	
C	C	D	A	B					B
	A		C	D		B			B
D	D		B			C		A	
B	B		D	C	A				A
					B	D	A	C	C
C		C		A			B	D	
		B			D	A	C		
		A			C		D	B	

11. LITS (Borders)

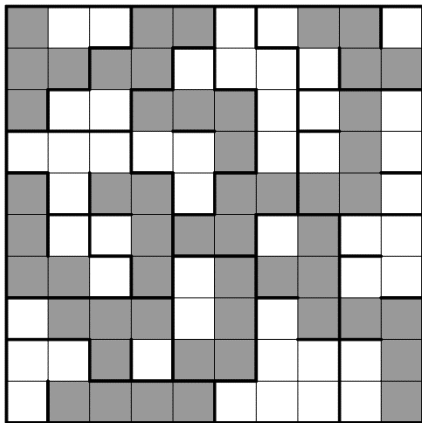

12. Ring-Ring (Masyu)

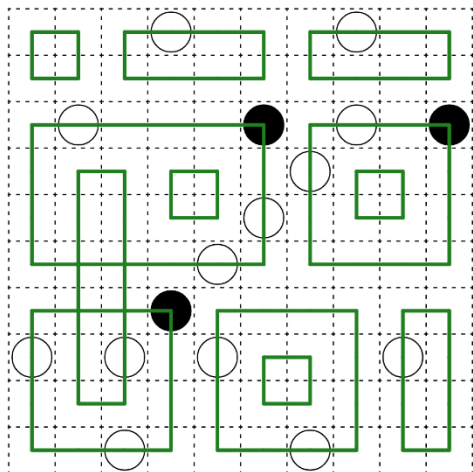

13/14. L-Words

A	B	S	E	A	D	O
K	O	W	O	S	T	R
P	R	A	D	N	A	E
A	T	W	T	O	Y	G
O	Y	A	E	R	N	E

BAKPAO DOES
 NOT ADORE
 WORT GENRE
 STAY AWAY

15. Pentopia

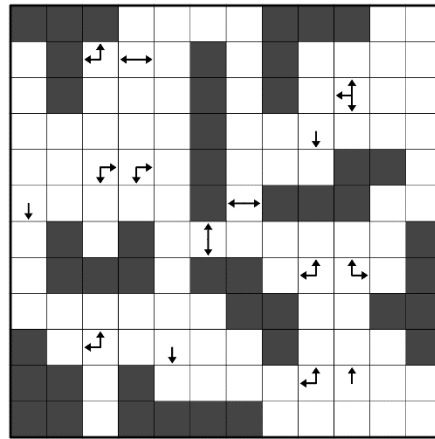

16. Voxas

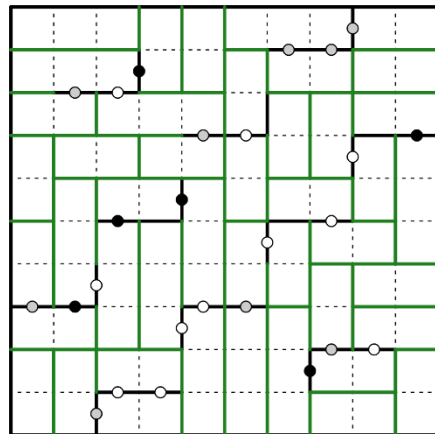

17. Arboretum

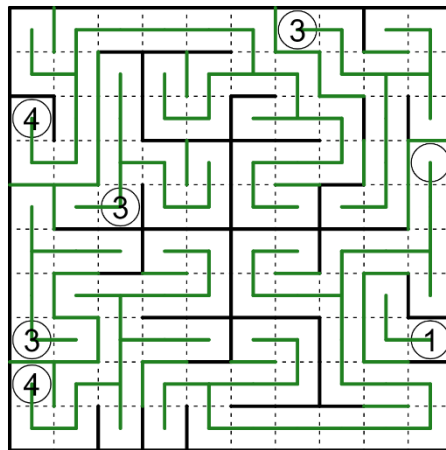

18. Aqre

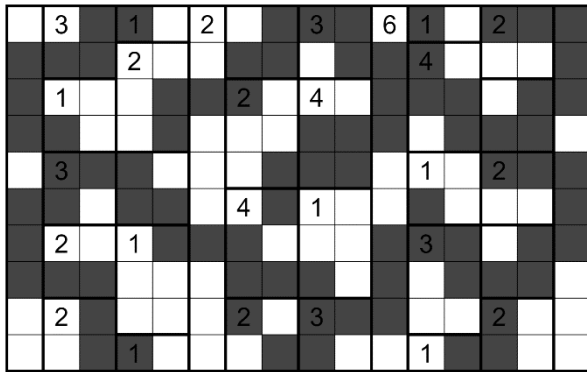

19. Icebarn

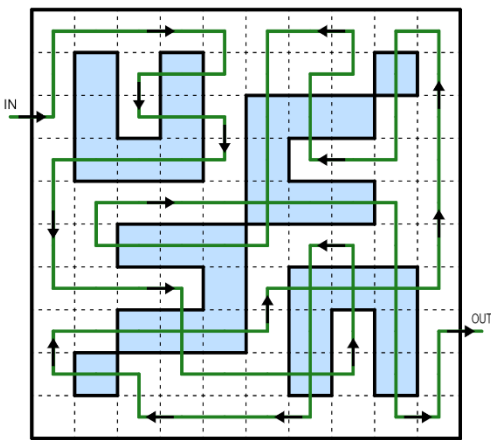

20. Eels

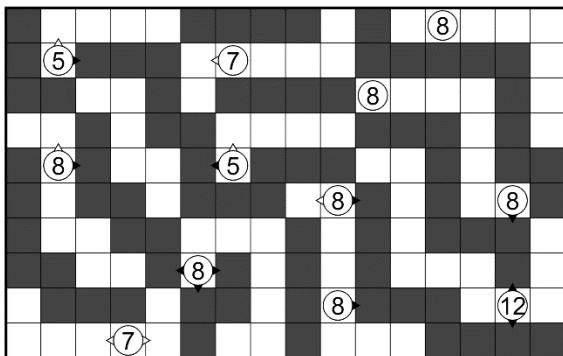

21. Rassi Silai

